

# ADJUSTABLE BAYONET STYLE THERMOCOUPLES AND RTDs

**A500**

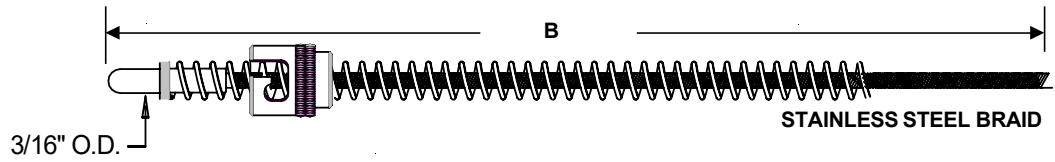

**A510**

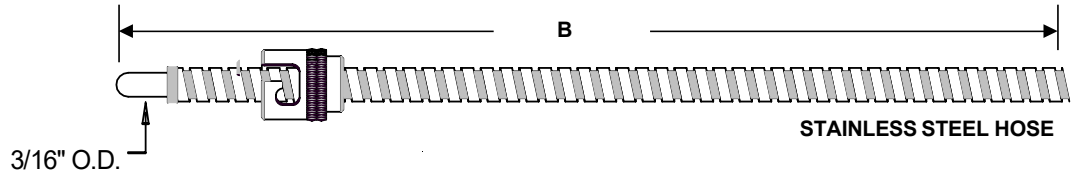

## NOZZLE STYLE

**A300**

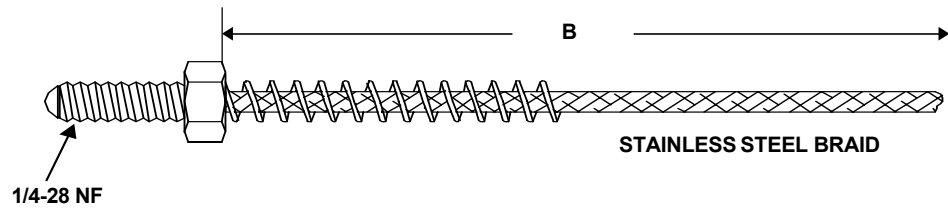

**A310**

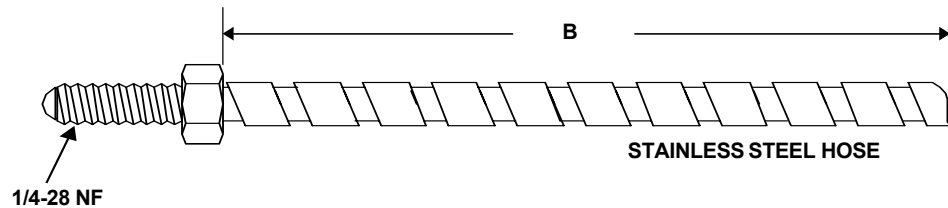

## HOW TO ORDER

|             | 1                        | 2                        | 3                        | 4                                   |
|-------------|--------------------------|--------------------------|--------------------------|-------------------------------------|
| <b>A500</b> | <input type="checkbox"/> | <input type="checkbox"/> | <input type="checkbox"/> | <input type="checkbox"/>            |
| <b>A510</b> | 1                        | 2                        | 3                        | 4                                   |
| <b>A300</b> | TYPE                     | "B" (INCH)               | TERMINAL                 | OPTION                              |
| <b>A310</b> | J                        | 48                       | 1                        | U - UNGROUNDED                      |
|             | K                        | 60                       | 2                        | M - METRIC DOUBLEUSLOT C            |
|             | RTD                      | 72                       | 3                        | X - SPECIAL                         |
|             |                          | 96                       | 4                        | C - NIST TRACABLE                   |
|             |                          | 120                      | 5                        | B - 1/8" NPT x 7/8" BAYONET ADAPTER |

### TERMINATIONS

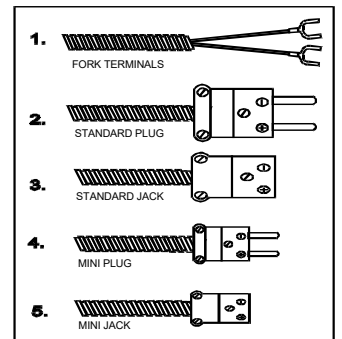

# FIXED BAYONET THERMOCOUPLES AND RTDs

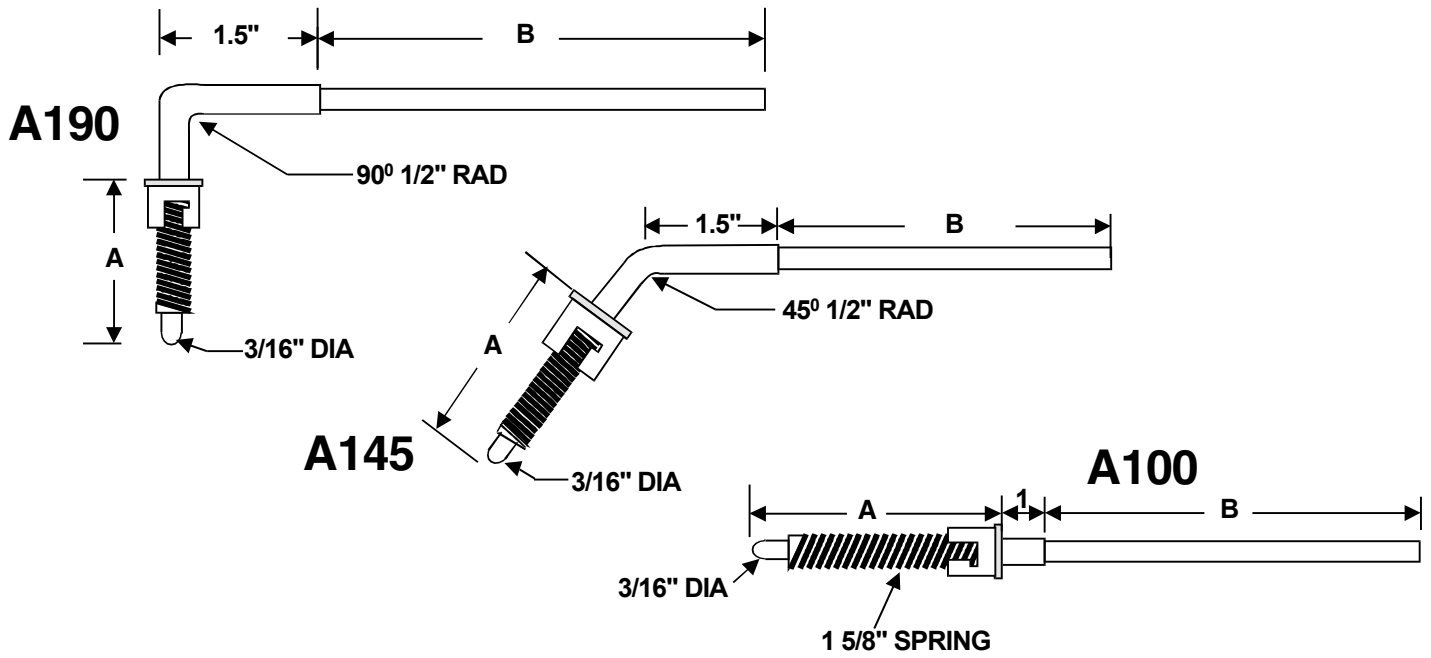

# FIXED COMPRESSION THERMOCOUPLES AND RTDs

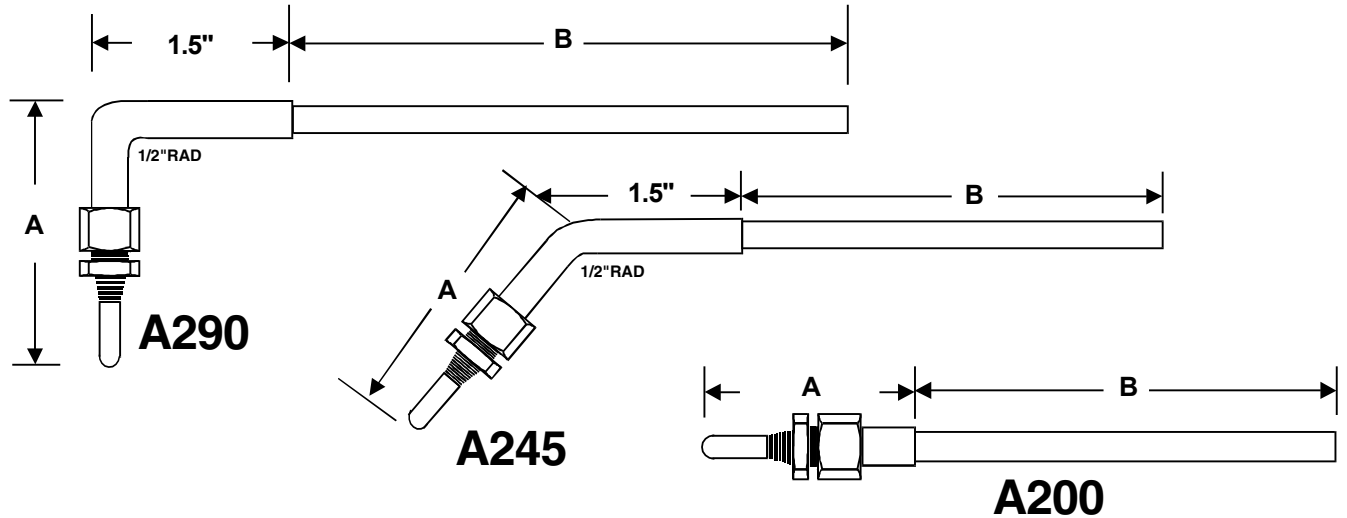

## HOW TO ORDER

|             |                          |                          |   |                          |                          |                          |                          |                          |
|-------------|--------------------------|--------------------------|---|--------------------------|--------------------------|--------------------------|--------------------------|--------------------------|
| <b>A200</b> | <input type="checkbox"/> | <input type="checkbox"/> | x | <input type="checkbox"/> | <input type="checkbox"/> | <input type="checkbox"/> | <input type="checkbox"/> | <input type="checkbox"/> |
| <b>A245</b> | 1                        | 2A                       |   | 2B                       | 3                        | 4                        | 5                        | 6                        |
| <b>A290</b> | TYPE                     | DIA                      |   | "A"                      | "B"                      | TERM                     | LEADS                    | OPTIONS                  |
|             | J                        | 1/8"                     |   |                          |                          | 1                        |                          | U - UNGROUNDED           |
|             | K                        | 3/16"                    |   |                          |                          | 2                        |                          | X - SPECIAL              |
|             | T                        | 1/4"                     |   |                          |                          | 3                        |                          | N - NONE                 |
|             | RTD                      | SPECIAL                  |   |                          |                          | 4                        |                          | C - NIST TRACABLE        |
|             |                          |                          |   |                          |                          | 5                        |                          | F - FIBERGLASS           |
|             |                          |                          |   |                          |                          |                          |                          | B - SS BRAID             |
|             |                          |                          |   |                          |                          |                          |                          | H - SS HOSE              |
|             |                          |                          |   |                          |                          |                          |                          | T - TEFLON               |
|             |                          |                          |   |                          |                          |                          |                          | FS - FIBERGLASS STRANDED |
|             |                          |                          |   |                          |                          |                          |                          | N - NO FITTING           |
|             |                          |                          |   |                          |                          |                          |                          | S2 - 1/2" SS NPT         |
|             |                          |                          |   |                          |                          |                          |                          | S4 - 1/4" SS NPT         |
|             |                          |                          |   |                          |                          |                          |                          | S8 - 1/8" SS NPT         |
|             |                          |                          |   |                          |                          |                          |                          | B2 - 1/2" BRASS NPT      |
|             |                          |                          |   |                          |                          |                          |                          | B4 - 1/4" BRASS NPT      |
|             |                          |                          |   |                          |                          |                          |                          | B8 - 1/8" BRASS NPT      |

|             |                          |                          |                          |                          |                          |                                       |
|-------------|--------------------------|--------------------------|--------------------------|--------------------------|--------------------------|---------------------------------------|
| <b>A100</b> | <input type="checkbox"/> | <input type="checkbox"/> | <input type="checkbox"/> | <input type="checkbox"/> | <input type="checkbox"/> | <input type="checkbox"/>              |
| <b>A145</b> | 1                        | 2                        | 3                        | 4                        | 5                        | 6                                     |
| <b>A190</b> | TYPE                     | "A"                      | "B"                      | TERM                     | LEADS                    | OPTIONS                               |
|             | J                        |                          |                          | 1                        |                          | U - UNGROUNDED                        |
|             | K                        |                          |                          | 2                        |                          | X - SPECIAL                           |
|             | T                        |                          |                          | 3                        |                          | B - 1/8" NPT x 7/8" L BAYONET ADAPTER |
|             | RTD                      |                          |                          |                          |                          | C - NIST TRACABLE                     |
|             |                          |                          |                          |                          |                          | M - METRIC CAP                        |
|             |                          |                          |                          |                          |                          | F - FIBERGLASS                        |
|             |                          |                          |                          |                          |                          | B - SS BRAID                          |
|             |                          |                          |                          |                          |                          | H - SS HOSE                           |
|             |                          |                          |                          |                          |                          | T - TEFLON                            |
|             |                          |                          |                          |                          |                          | FS - FIBERGLASS STRANDED              |

# RING TERMINAL THERMOCOUPLE

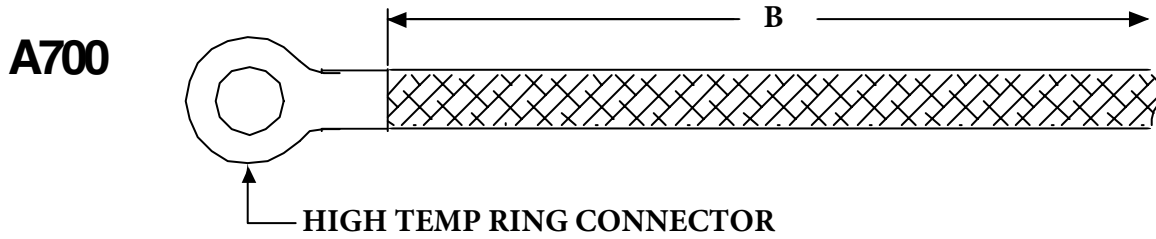

# SHIM STOCK THERMOCOUPLES

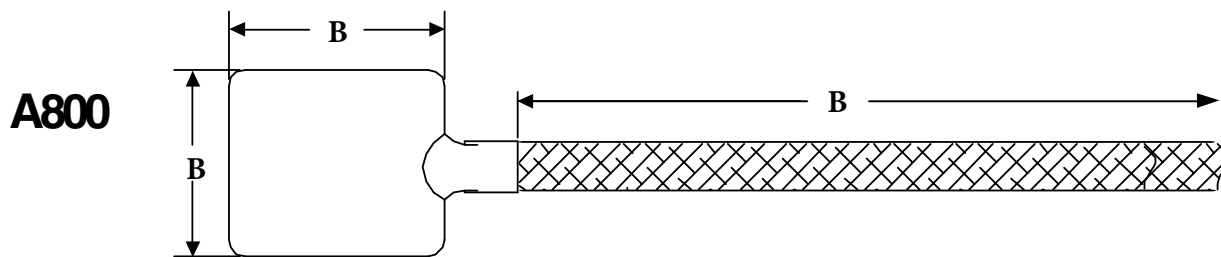

# PIPE CLAMP THERMOCOUPLE

**APIP**

| SIZE CODE | RANGE          |
|-----------|----------------|
| 22        | 0.22" to 0.62" |
| 31        | 0.31" to 0.87" |
| 56        | 0.56" to 1.25" |
| 110       | 1.10" to 2.00" |
| 155       | 1.55" to 2.50" |
| 280       | 2.80" to 3.75" |

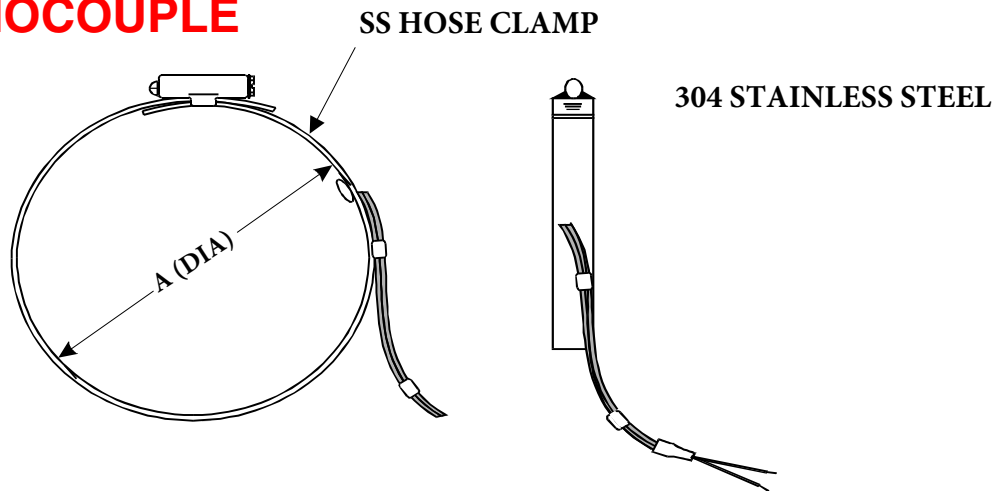

## HOW TO ORDER

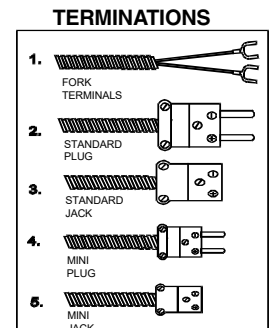
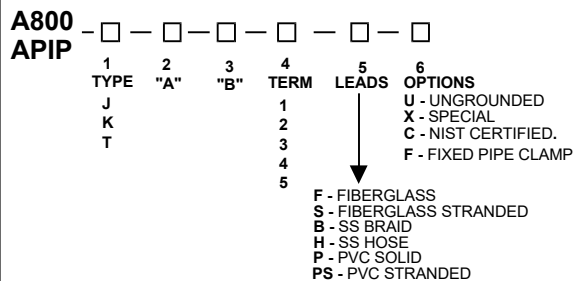
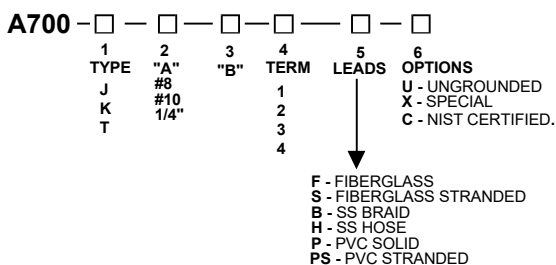

# PLASTIC MELT THERMOCOUPLES & RTDs



**A400**

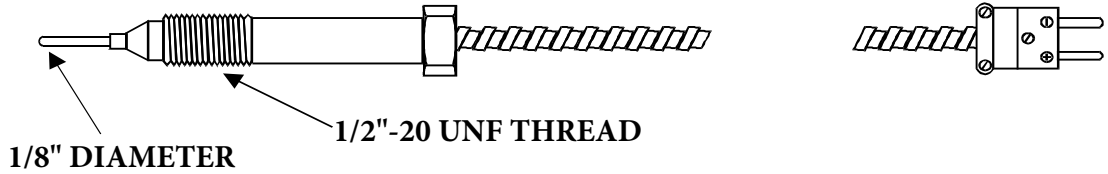

## EXTENSION CABLES

**A900**

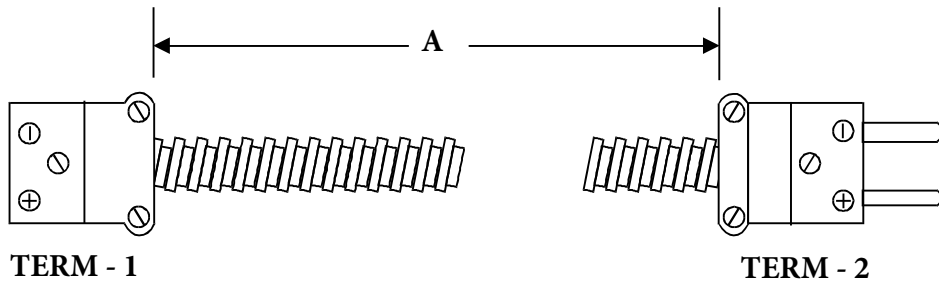

## HOW TO ORDER

**A400** - [ ] - [ ] - [ ] - [ ] - [ ] - [ ]

| 1    | 2      | 3   | 4   | 5    | 5     | 6                  |
|------|--------|-----|-----|------|-------|--------------------|
| TYPE | "A"    | "B" | "C" | TERM | LEADS | OPTIONS            |
| J    | 0"     | 3"  |     | 1    | ↓     | U - UNGROUNDED     |
| K    | 1/4"   | 6"  |     | 2    |       | X - SPECIAL        |
| T    | CUSTOM | 9"  |     | 3    |       | C - NIST TRACEABLE |
|      |        | 12" |     | 4    |       |                    |
|      |        |     |     | 5    |       |                    |

N - NONES  
 FS - FIBERGLASS STRANDED  
 F - FIBERGLASS  
 H - SS HOSE  
 B - SS BRAID

**A900** - [ ] - [ ] - [ ] - [ ] - [ ]

| 1    | 2   | 3                        | 4      | 5      |
|------|-----|--------------------------|--------|--------|
| TYPE | "A" | LEADS                    | TERM-1 | TERM-2 |
|      |     | ↓                        |        |        |
|      |     | B - SS BRAID             |        |        |
|      |     | FS - FIBERGLASS STRANDED |        |        |
|      |     | F - FIBERGLASS           |        |        |
|      |     | H - SS HOSE              |        |        |
|      |     | P - PVC SOLID            |        |        |
|      |     | PS - PVC STRANDED        |        |        |

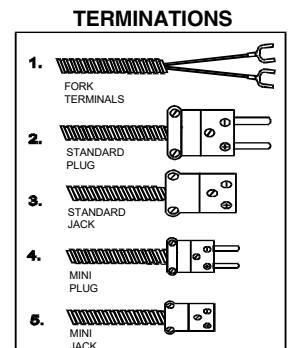

# MgO INSULATED THERMOCOUPLE & RTDs

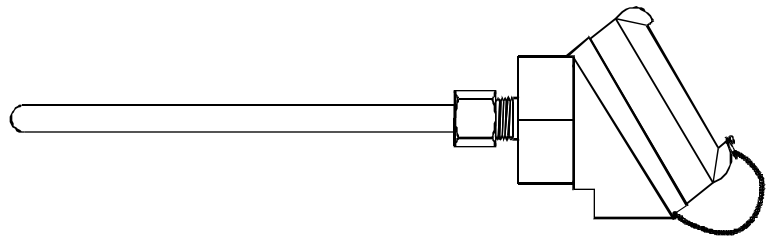
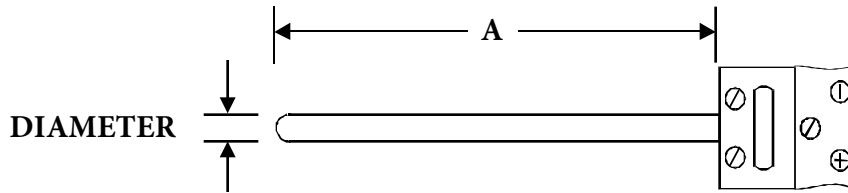
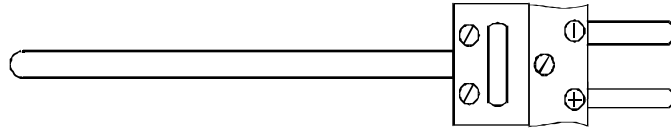

**FLANGE MOUNT**

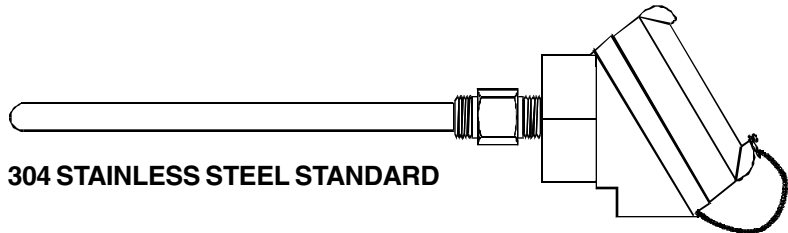
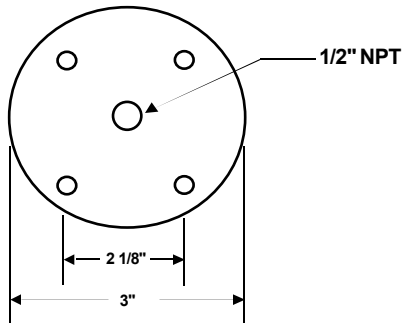

**304 STAINLESS STEEL STANDARD**

## HOW TO ORDER

| TYPE                  | "A" | DIAMETER | JUNCTION       | TERMINATION                   | PROCESS CONNECT     | OPTIONS                 |
|-----------------------|-----|----------|----------------|-------------------------------|---------------------|-------------------------|
| J                     |     | 1/16"    | E - EXPOSED    | P - MALE PLUG                 | N - NONE            | S - SPRING LOADED       |
| JJ - DUPLEX           |     | 1/8"     | G - GROUNDED   | F - FEMALE JACK               | B2 - 1/2" BRASS NPT | T - TRANSMITTER (RANGE) |
| K                     |     | 3/16"    | U - UNGROUNDED | I - CAST IRON                 | S2 - 1/2" STEEL NPT | 1600- INCONEL 600       |
| KK - DUPLEX           |     | 1/4"     | 3 - 3 WIRE     | L - L/G CAST ALU              | SS2 - 1/2" SS NPT   | 1800- INCONEL 800       |
| T                     |     | 5/16"    | 4 - 4 WIRE     | AS - SMALL CAST ALU           | B4 - 1/4" BRASS NPT | 316 - 316 SS            |
| TT - DUPLEX           |     | 3/8"     |                | PL - PLASTIC                  | S4 - 1/4" STEEL NPT | N - NO TERM BLOCK       |
| RT2 (200°C)           |     |          |                | ALE - CAST ALU EXPLOSION      | SS4 - 1/4" SS NPT   | TRANSMITTER READY       |
| RTD2 - DUPLEX (200°C) |     |          |                | FDA - FDA COMPLAINT PLASTIC   | FL - FLANGE MOUNT   | C - NIST TRACABLE       |
| SPECIAL               |     |          |                | E - EPOXY COATED ALUMINIUM    |                     |                         |
| RT4 (400°C)           |     |          |                | FDAF - FDA COMPLAINT FLIP TOP |                     |                         |
| RTD4 - DUPLEX (400°C) |     |          |                |                               |                     |                         |

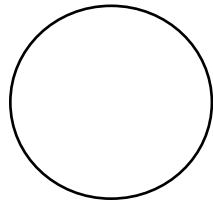



# MAGNET STYLE THERMOCOUPLE

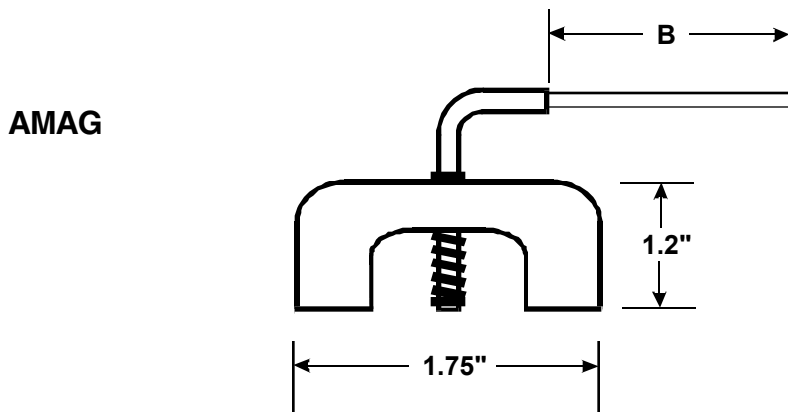

## THERMOCOUPLE ELEMENTS

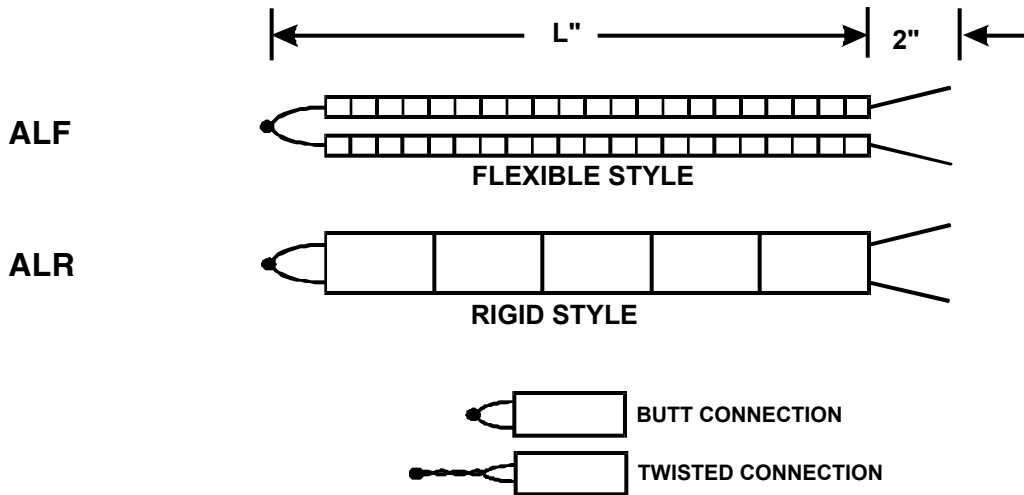

## HOW TO ORDER

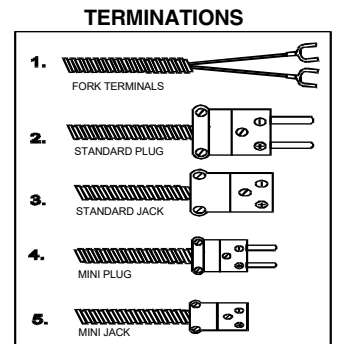
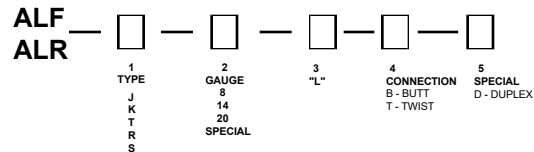
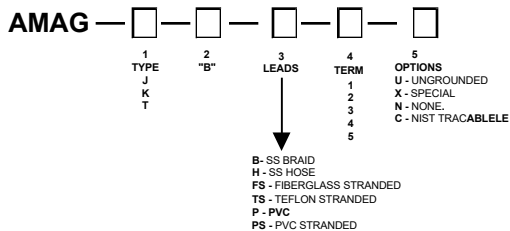



# PIPE WELL THERMOCOUPLE & RTD ASSEMBLIES

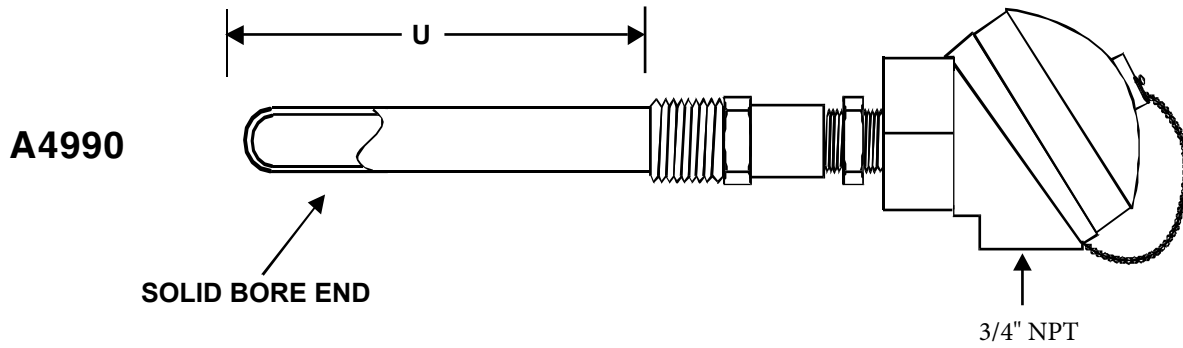

# FLANGE THERMOWELL SENSOR ASSEMBLIES

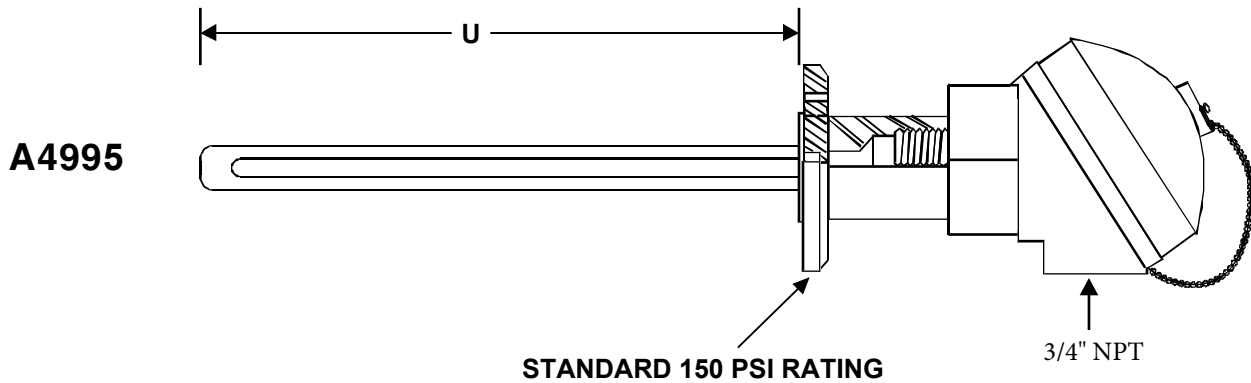

## HOW TO ORDER

A4990  
A4995

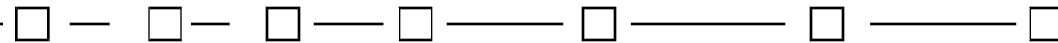

**SENSOR**  
J 4"  
JJ - DUPLEX 6"  
K 8"  
KK - DUPLEX 10"  
T SPECIAL  
TT - DUPLEX  
RTD (200° C)  
RTDD - DUPLEX (200° C)  
SPECIAL  
RT4 (400° C)  
RT44 - DUPLEX (400° C)

**U (in)**  
4"  
6"  
8"  
10"  
SPECIAL

**MATERIAL**  
ST - STEEL  
S - 304 SS  
S6 - 316 SS  
I600 - INCONEL 600  
I800 - INCOLOY 800  
SPECIAL

**THREAD / FLANGE**  
1/4"  
1/2"  
3/4"  
1.0"  
1F - 1" FLANGE  
1.5F - 1.5" FLANGE  
2F - 2" FLANGE

**JUNCTION**  
G - GROUNDED  
U - UNGROUNDED  
3 - 3 WIRE  
4 - 4 WIRE

**HEAD MATERIAL**  
I - CAST IRON  
AL - LARGE CAST ALU  
AS - SMALL CAST ALU  
PL - PLASTIC HEAD  
PL - PLASTIC HEAD  
ALE - CAST ALU. EXPLOSION  
FDA - FDA COMPLIANT PLASTIC  
E - EPOXY COATED ALUMINIUM  
FDAF - FDA COMPLIANT FLIP TOP

**OPTIONS**  
T - TRANSMITTER (RANGE)  
S - SPRING LOADED  
U - UNION & NIPPLE  
3 - 300 PSI FLANGE  
6 - 600 PSI FLANGE  
C - NIST TRACEABLE  
N - NO TERMINAL BLOCK  
TRANSMITTER READY

# SANITARY TRI-CLAMP ASSEMBLIES

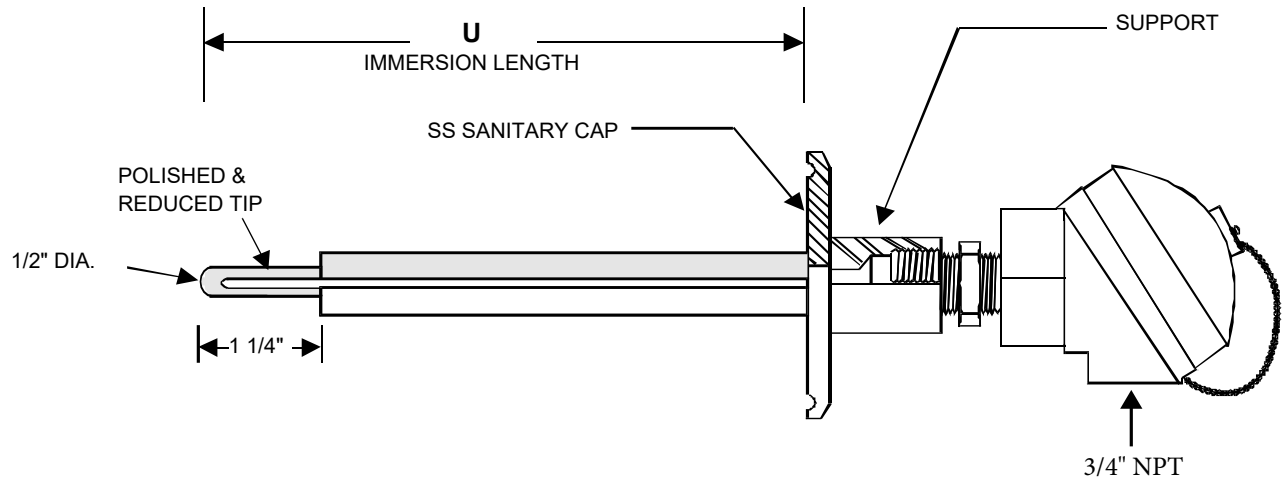

## HOW TO ORDER

A4950 —  —  —  —  —  —  —

**SENSOR**

J  
 JJ - DUPLEX  
 K  
 KK - DUPLEX  
 T  
 TT - DUPLEX  
 RTD (200° C)  
 RTDD - DUPLEX (200° C)  
 SPECIAL  
 RT4 (400° C)  
 RT44 - DUPLEX (400° C)

**U (in)**

4"  
 6"  
 8"  
 10"  
 SPECIAL

**JUNCTION**

G - GROUNDED  
 U - UNGROUNDED  
 3 - 3 WIRE  
 4 - 4 WIRE

**HEAD MATERIAL**

I - CAST IRON  
 AL - LARGE CAST ALUMINIUM  
 AS - SMALL CAST ALUMINIUM  
 PL - PLASTIC HEAD  
 ALE - CAST ALU. EXPLOSION  
 FDA - FDA COMPLIANT PLASTIC  
 E - EPOXY COATED ALUMINIUM  
 FDAF - FDA COMPLIANT FLIP TOP

**CAP SIZE**

1.5"  
 2"  
 3"  
 4"

**OPTIONS**

T - TRANSMITTER (RANGE)  
 S - SPRING LOADED  
 U - UNION & NIPPLE  
 C - NIST TRACEABLE  
 N - NO TERMINAL BLOCK  
 TRANSMITTER READY

## CIP SANITARY CONNECTED RTDs

A4940

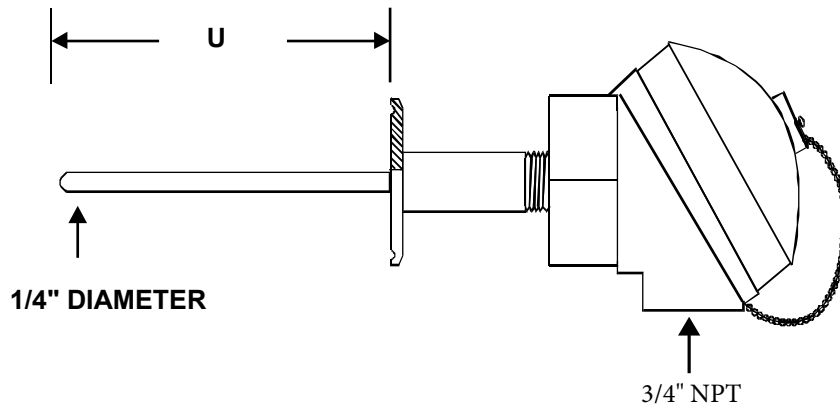

## CIP SANITARY REDUCED TIP RTD'S

A4945

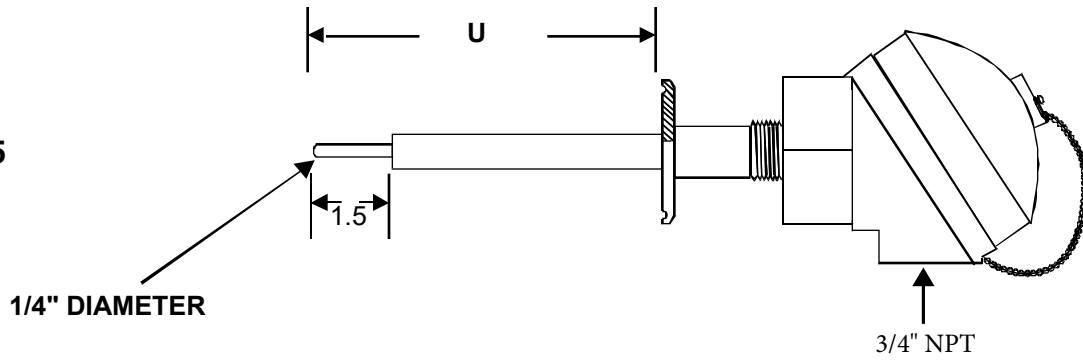

## HOW TO ORDER

A4940  
A4945

| SENSOR                 | U (in)  | JUNCTION       | HEAD MATERIAL                 | CAP SIZE | OPTIONS                 |
|------------------------|---------|----------------|-------------------------------|----------|-------------------------|
| J                      | 4"      | G - GROUNDED   | AL - LARGE CAST ALUMINIUM     | 1.5"     | T - TRANSMITTER (RANGE) |
| JJ - DUPLEX            | 6"      | U - UNGROUNDED | PL - PLASTIC HEAD             | 2"       | U - UNION & NIPPLE      |
| K                      | 8"      | 3 - 3 WIRE     | FDA - FDA COMPLIANT PLASTIC   | 3"       | C - NIST TRACEABLE      |
| KK - DUPLEX            | 10"     | 4 - 4 WIRE     | E - EPOXY COATED ALUMINIUM    | 4"       | N - NO TERMINAL BLOCK   |
| T                      | SPECIAL |                | FDAF - FDA COMPLIANT FLIP TOP |          | TRANSMITTER READY       |
| TT - DUPLEX            |         |                |                               |          |                         |
| RTD (200° C)           |         |                |                               |          |                         |
| RTDD - DUPLEX (200° C) |         |                |                               |          |                         |
| SPECIAL                |         |                |                               |          |                         |
| RT4 (400° C)           |         |                |                               |          |                         |
| RT44 - DUPLEX (400° C) |         |                |                               |          |                         |

# DRILLED THERMOWELL - THREAD CONNECTION T-SERIES

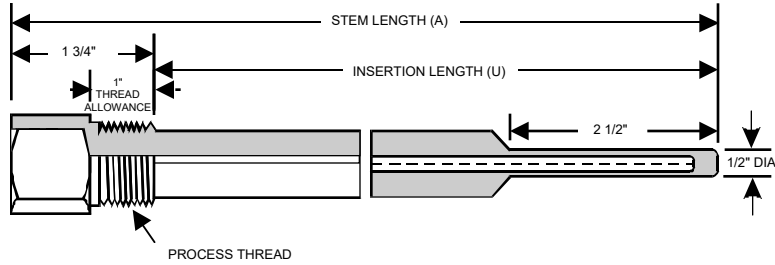

T —  —  —  —

| MATERIAL   | STEM A (in) | PROCESS CONNECT | INST. CONNECT  |
|------------|-------------|-----------------|----------------|
| B - BRASS  | 2"          | 1/2 - 1/2" NPT  | 1/2 - 1/2" NPT |
| S - SS304  | 4"          | 3/4 - 3/4" NPT  | 3/4 - 3/4" NPT |
| S6 - SS316 | 6"          | 1 - 1" NPT      | SPECIAL        |
| SPECIAL    | 9"          | SPECIAL         | SPECIAL        |

# DRILLED THERMOWELL - FLANGED CONNECTION TF-SERIES

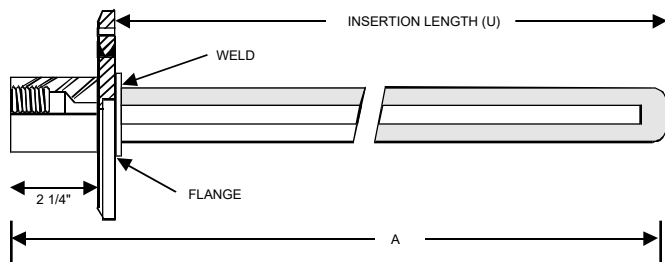

TF —  —  —  —  —

| MATERIAL   | STEM A (in) | FLANGE  | INST. CONNECT | PRESSURE RATING |
|------------|-------------|---------|---------------|-----------------|
| S - SS304  | 2"          | 1"      | 1/2"          | 150 PSI         |
| S6 - SS316 | 4"          | 1 1/2"  | 3/4"          | 300 PSI         |
| SPECIAL    | 6"          | 2"      | 1"            | 600 PSI         |
|            | 9"          | SPECIAL |               |                 |

# SANITARY TRI-CLAMP THERMOWELL SAN-SERIES

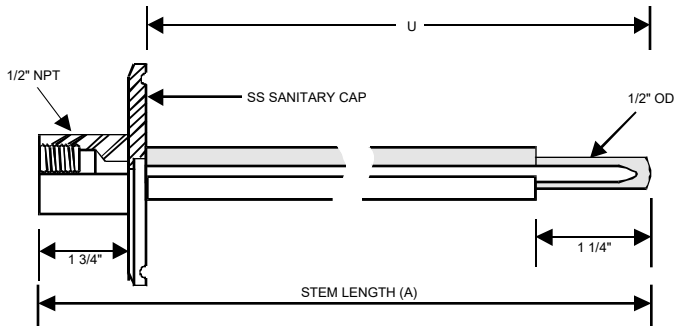

SAN —  —

| CAP SIZE | STEM A (in) |
|----------|-------------|
| 1.5"     | 4"          |
| 2"       | 6"          |
| 2.5"     | 7.5"        |
| 3"       | SPECIAL     |
| SPECIAL  |             |